

District XI AAA

AAA

120

1 Enriquez, Cameron 12 Stroudsburg [27-4]

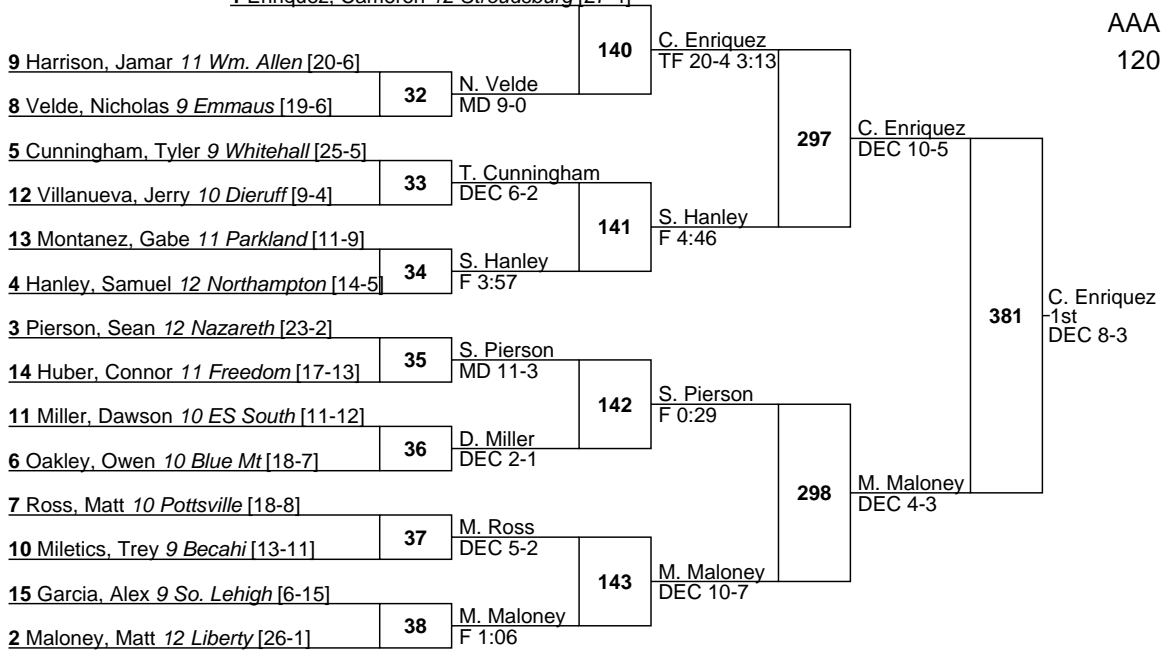

L32 J. Harrison

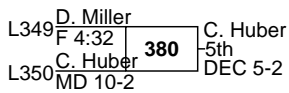
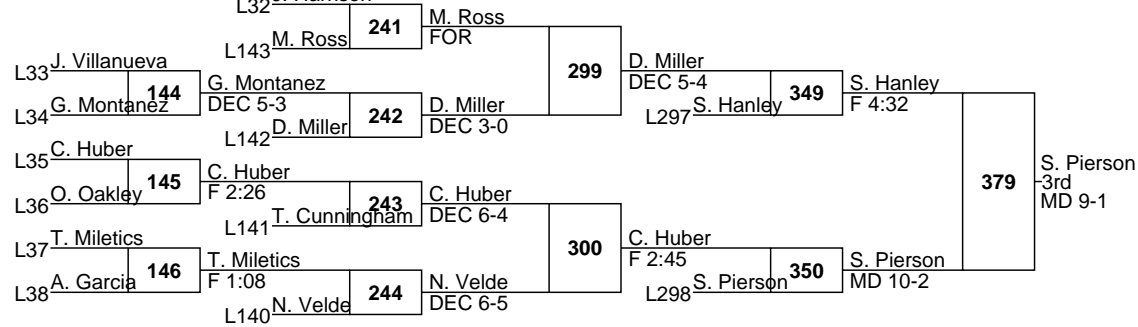

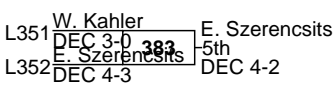
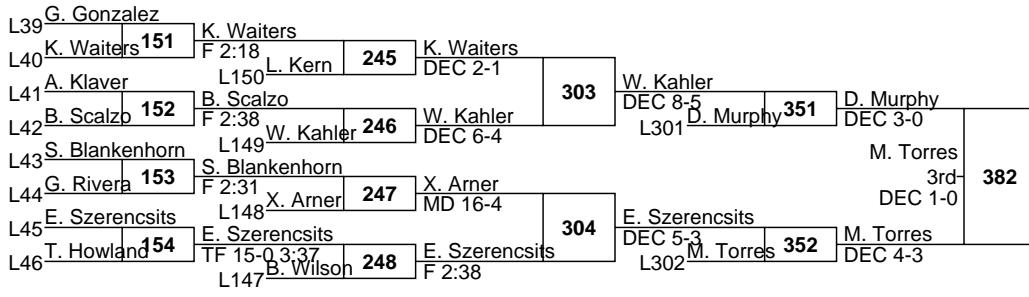
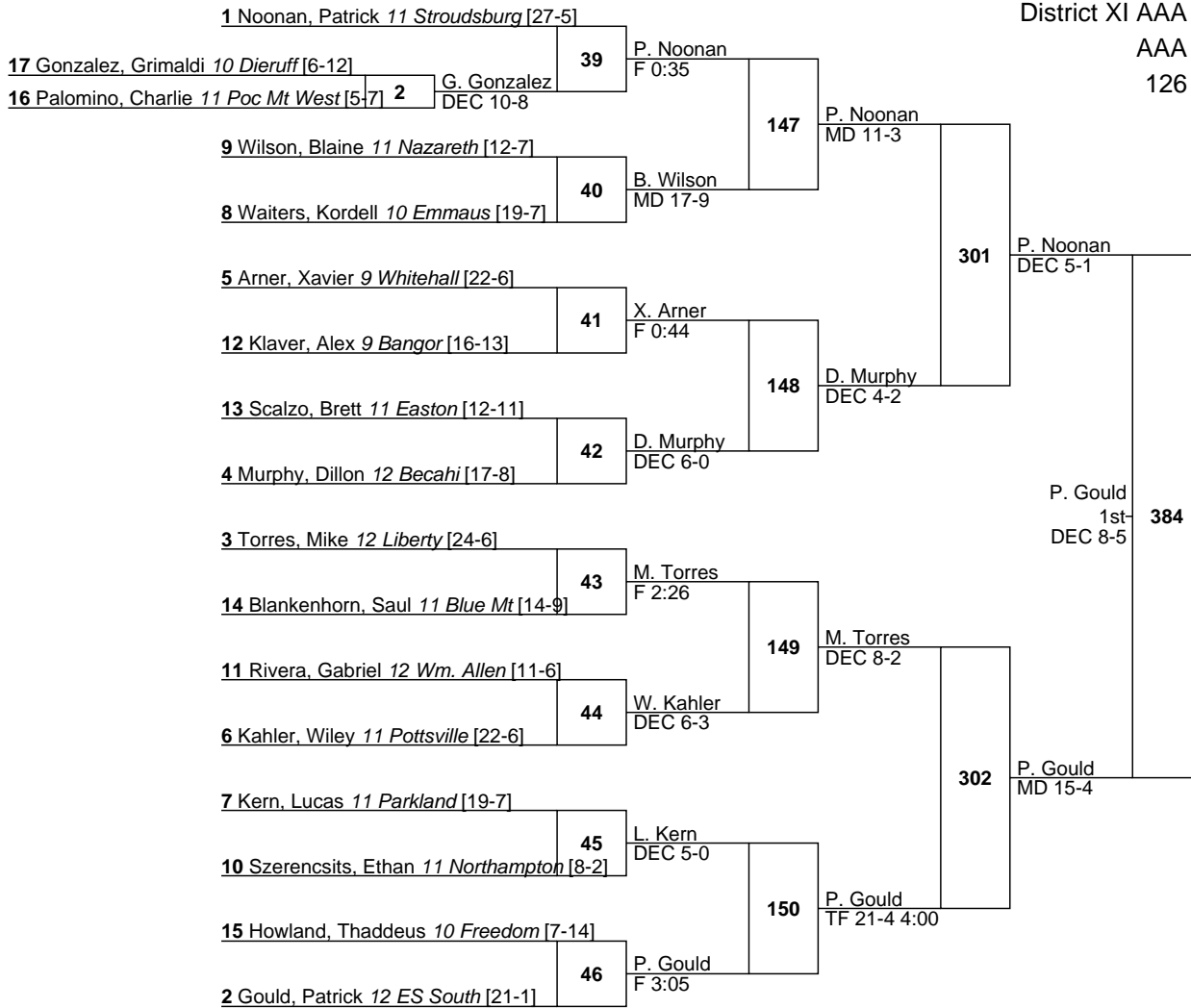

1 Chlebove, Julian 12 Northampton [24-3]

17 Nieves, Chris 9 Freedom [0-6] 47 J. Chlebove F 2:59

16 Peralta Martinez, Isael 9 Wm. Allen [1-6] 3 C. Nieves F 1:43

9 Hagan, Ian 11 Poc Mt East [14-10]

8 McIntyre, Wayne 9 ES North [15-9] 48 W. McIntyre DEC 7-2

5 Gonzalez, Bryce 11 Pottsville [23-8]

12 Pasciak, Jeffrey 11 Stroudsburg [11-12] 49 B. Gonzalez F 2:52

13 Colasurdo, Christian 10 So. Lehigh [9-10]

4 Brown, Travis 12 Liberty [21-6] 50 T. Brown F 2:16

3 Clearie, Drew 10 Nazareth [24-8]

14 Scott, Quin 9 Emmaus [7-13] 51 D. Clearie F 0:49

11 Bryson, Kyron 10 Easton [12-11]

6 Grol, Joshua 12 Whitehall [17-9] 52 K. Bryson F 3:55

7 Acosta, Aaron 12 ES South [17-10]

10 Diaz, Bryan 11 Parkland [20-11] 53 A. Acosta DEC 9-8

15 Knapp, Gentry 10 Pleasant Valley [8-18]

2 Herrmann, Kenny 11 Becahi [16-4] 54 K. Herrmann F 0:23

155

J. Chlebove TF 20-4 4:18

305

J. Chlebove DEC 10-6

156

T. Brown F 5:14

387

J. Chlebove 1st F 4:58

157

D. Clearie DEC 7-0

306

K. Herrmann DEC 3-0

158

K. Herrmann TF 15-0 2:52

L47 C. Nieves

L48 I. Hagan 159

I. Hagan DEC 3-2

L158 A. Acosta 249

A. Acosta DEC 2-1

307

K. Bryson DEC 8-6

T. Brown DEC 1-0

L49 J. Pasciak

J. Pasciak F 1:26

L157 K. Bryson 250

K. Bryson MD 12-2

L305 T. Brown 353

L50 C. Colasurdo 160

C. Colasurdo F 1:26

L157 Q. Scott

Q. Scott DEC 6-3

L156 J. Grol 161

J. Grol DEC 6-3

L156 B. Gonzalez 251

B. Gonzalez F 4:18

L52 J. Grol 161

J. Grol DEC 6-3

L156 B. Diaz 162

B. Diaz F 1:36

L155 W. McIntyre 252

B. Diaz DEC 5-3

L53 B. Diaz 162

B. Diaz F 1:36

L155 W. McIntyre 252

W. McIntyre DEC 5-3

L306 D. Clearie 354

D. Clearie DEC 9-2

L54 G. Knapp 162

G. Knapp F 1:36

L155 W. McIntyre 252

W. McIntyre DEC 5-3

L306 D. Clearie 354

D. Clearie DEC 9-2

L353 K. Bryson DEC 1-0 336

B. Gonzalez 5th DEC 7-3

L354 B. Gonzalez DEC 9-2

B. Gonzalez DEC 7-3

385

D. Clearie 3rd DEC 9-2

308

B. Gonzalez F 4:01

L306 D. Clearie 354

D. Clearie DEC 9-2

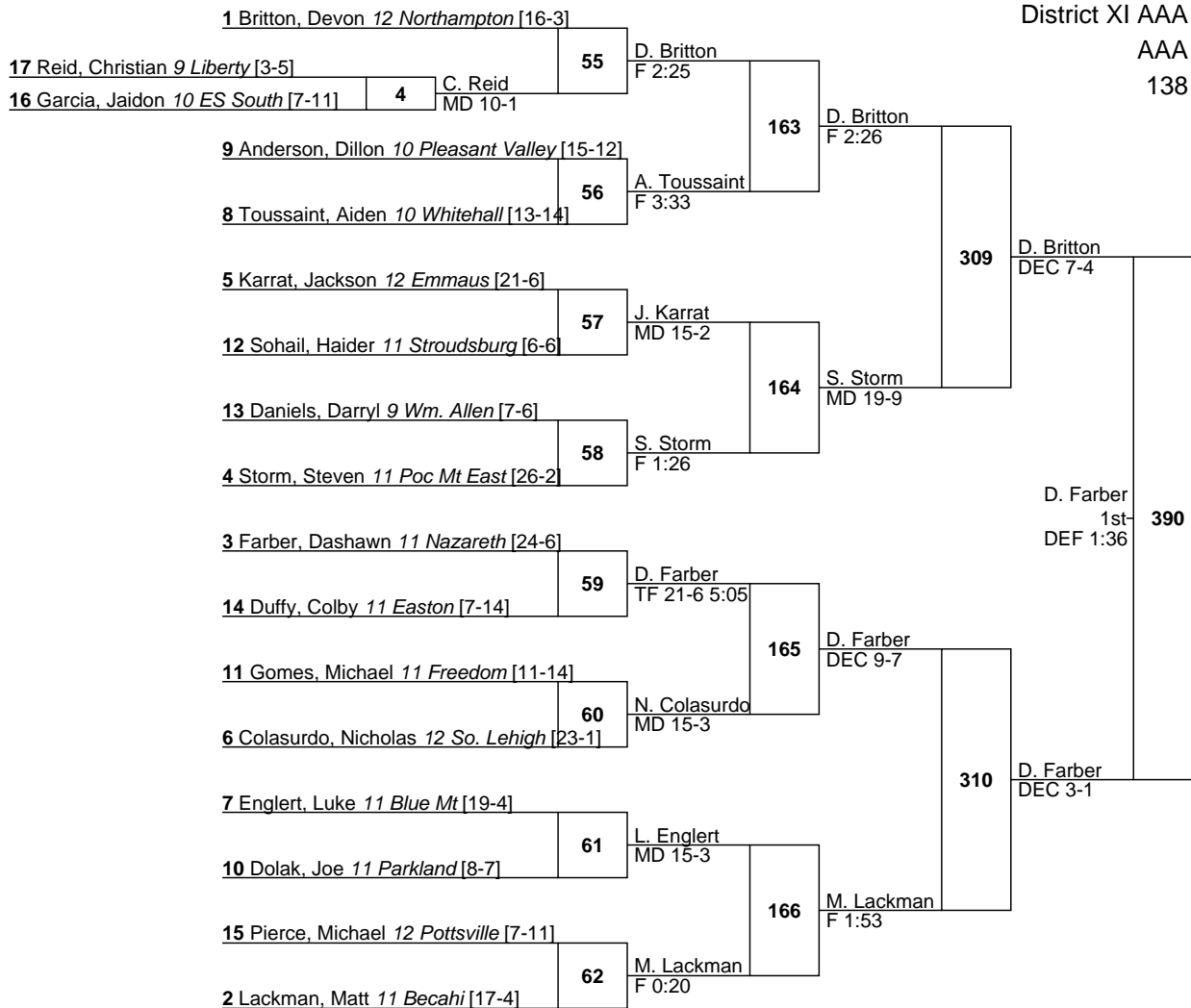

D. Farber
1st
DEF 1:36

390

D. Farber
DEC 3-1

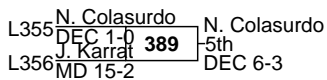
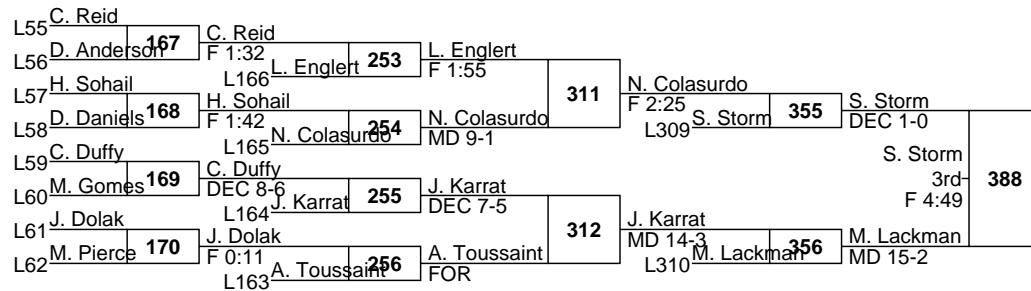

1 Anderson, Ryan 12 <i>Becahi</i> [24-0]	63	R. Anderson F 0:41	171	R. Anderson TF 18-3 3:44	313	R. Anderson F 1:36	393
17 Feldman, Jonathan 10 <i>Pleasant Valley</i> [1-6]	5	T. Sherpa F 1:18					
16 Sherpa, Tashi 10 <i>ES North</i> [2-16]	5	T. Sherpa F 1:18	172	J. Rezac F 1:47	314	J. Condomitti F 1:49	
9 Caciolo, Dominic 12 <i>So. Lehigh</i> [11-9]	64	B. Breithaupt F 2:33					
8 Breithaupt, Braden 12 <i>Stroudsburg</i> [9-5]	64	B. Breithaupt F 2:33	174	J. Condomitti F 3:29	315	K. Cummings DEC 5-2	
5 Farrell, Daniel 11 <i>Blue Mt</i> [20-8]	65	D. Farrell MD 12-4					
12 Reto, Jared 10 <i>Bangor</i> [10-16]	65	D. Farrell MD 12-4	173	N. Stefanik F 2:23	314	J. Condomitti F 1:49	
13 Brion, Jack 9 <i>Emmaus</i> [6-16]	66	J. Rezac F 0:44					
4 Rezac, Jason 11 <i>Liberty</i> [24-7]	66	J. Rezac F 0:44	174	J. Condomitti F 3:29	315	K. Cummings DEC 5-2	
3 Stefanik, Nathan 11 <i>Nazareth</i> [5-1]	67	N. Stefanik F 0:31					
14 Weirich, Stephen 12 <i>Poc Mt West</i> [6-12]	67	N. Stefanik F 0:31	173	N. Stefanik F 2:23	314	J. Condomitti F 1:49	
11 Storm, Shane 11 <i>Freedom</i> [11-13]	68	G. Iannelli F 5:55					
6 Iannelli, Gino 11 <i>Poc Mt East</i> [19-10]	68	G. Iannelli F 5:55	174	J. Condomitti F 3:29	315	K. Cummings DEC 5-2	
7 Cummings, Kale 12 <i>Parkland</i> [17-9]	69	K. Cummings DEC 9-2					
10 Bohorad, Dylan 10 <i>Pottsville</i> [8-9]	69	K. Cummings DEC 9-2	174	J. Condomitti F 3:29	315	K. Cummings DEC 5-2	
15 Gonzalez, Landolfy 10 <i>Wm. Allen</i> [3-12]	6	L. Gonzalez F 0:08					
18 Apgar, Dominick 10 <i>Easton</i> [1-1]	6	L. Gonzalez F 0:08	174	J. Condomitti F 3:29	315	K. Cummings DEC 5-2	
2 Condomitti, Jagger 10 <i>Northampton</i> [27-4]	70	J. Condomitti F 1:13					

L63 T. Sherpa	L175 D. Caciolo	L257 K. Cummings	315	K. Cummings DEC 5-2	357 J. Rezac	J. Rezac F 2:05
L64 D. Caciolo	F 0:10	DEC 11-4				
L65 J. Reto	L174 K. Cummings	L258 G. Iannelli	316	B. Breithaupt MD 15-2	N. Stefanik MD 19-6	358 N. Stefanik
L66 J. Brion	F 4:57	F 1:33				
L67 S. Weirich	L173 S. Storm	L259 D. Farrell	316	B. Breithaupt MD 15-2	N. Stefanik MD 19-6	358 N. Stefanik
L68 S. Storm	DEC 6-3	F 3:31				
L69 D. Bohorad	L172 D. Farrell	L260 B. Breithaupt	316	B. Breithaupt MD 15-2	N. Stefanik MD 19-6	358 N. Stefanik
L70 L. Gonzalez	F 0:33	TF 17-2 2:20				

L357 K. Cummings	K. Cummings
F 2:05	5th
L358 B. Breithaupt	DEC 7-2
MD 19-6	

1 Handlovic, Cole 11 *Becahi* [25-5]

17 Lewis, Ceasar 11 *Poc Mt West* [3-6] 71

16 landoli, Edward 10 *Pleasant Valley* [4-4] 7 E. landoli DEC 7-6

C. Handlovic F 0:50

179

C. Handlovic TF 25-10 5:20

9 Hogan, Dylan 10 *ES North* [16-10]

72

J. Koerwitz MD 12-4

8 Koerwitz, Jake 12 *Easton* [14-9]

5 Mastrogiovanni, Paulie 12 *Bangor* [24-4]

73

P. Mastrogiovanni F 4:20

12 Colon, Michael 12 *Dieruff* [11-15]

13 Jurado, Chris 9 *Freedom* [11-16]

74

A. Schneider F 5:36

4 Schneider, Andrew 12 *Stroudsburg* [21-5]

3 Dressler, Jake 11 *Nazareth* [22-6]

75

J. Dressler F 0:47

19 Ensley, Corbin 12 *ES South* [1-1]

14 Treacy, Liam 12 *So. Lehigh* [4-9] 8 C. Ensley F 1:55

181

J. Dressler DEC 8-1

11 Santiago, Nick 12 *Liberty* [9-9]

76

K. Clark F 2:40

6 Clark, Kai 11 *Whitehall* [18-5]

7 Groller, Jared 9 *Emmaus* [17-10]

77

B. Reber F 1:24

10 Reber, Brandin 12 *Blue Mt* [11-9]

182

M. Kistler F 1:34

15 Lansenderfer, Mason 12 *Parkland* [4-13]

18 Shappell, Bryce 9 *Pottsville* [2-4] 9 M. Lansenderfer TF 16-0 5:16

78

M. Kistler MD 15-3

2 Kistler, Michael 12 *Northampton* [28-5]

317 C. Handlovic F 3:00

396 C. Handlovic 1st MD 16-7

318 M. Kistler MD 12-2

L71 E. landoli

L72 D. Hogan 183

D. Hogan F 1:24

B. Reber 261 MD 12-4

L73 M. Colon

L182

319

K. Clark F 2:09

P. Mastrogiovanni DEC 8-5

L74 C. Jurado 184

F 2:10

K. Clark 262 F 0:49

L317

P. Mastrogiovanni DEC 8-5

L75 C. Ensley

L181

J. Dressler

L76 N. Santiago 185

DEC 7-3

A. Schneider 263 DEC 7-3

A. Schneider

J. Dressler 3rd DEC 5-0

L77 J. Groller

L180

A. Schneider 320

A. Schneider DEC 9-2

J. Dressler 360 F 4:53

L78 M. Lansenderfer 186

F 0:15

J. Koerwitz 264 DEC 1-0

J. Groller

J. Dressler

L359 K. Clark

DEC 8-5

A. Schneider 395 5th

L360 A. Schneider

F 4:53

DEC 5-2

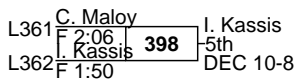
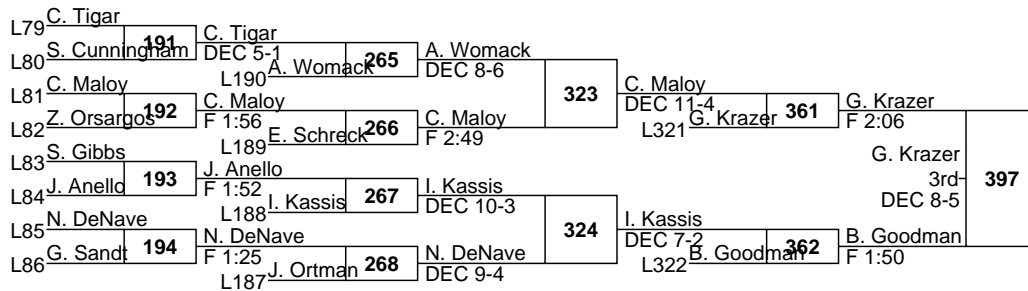
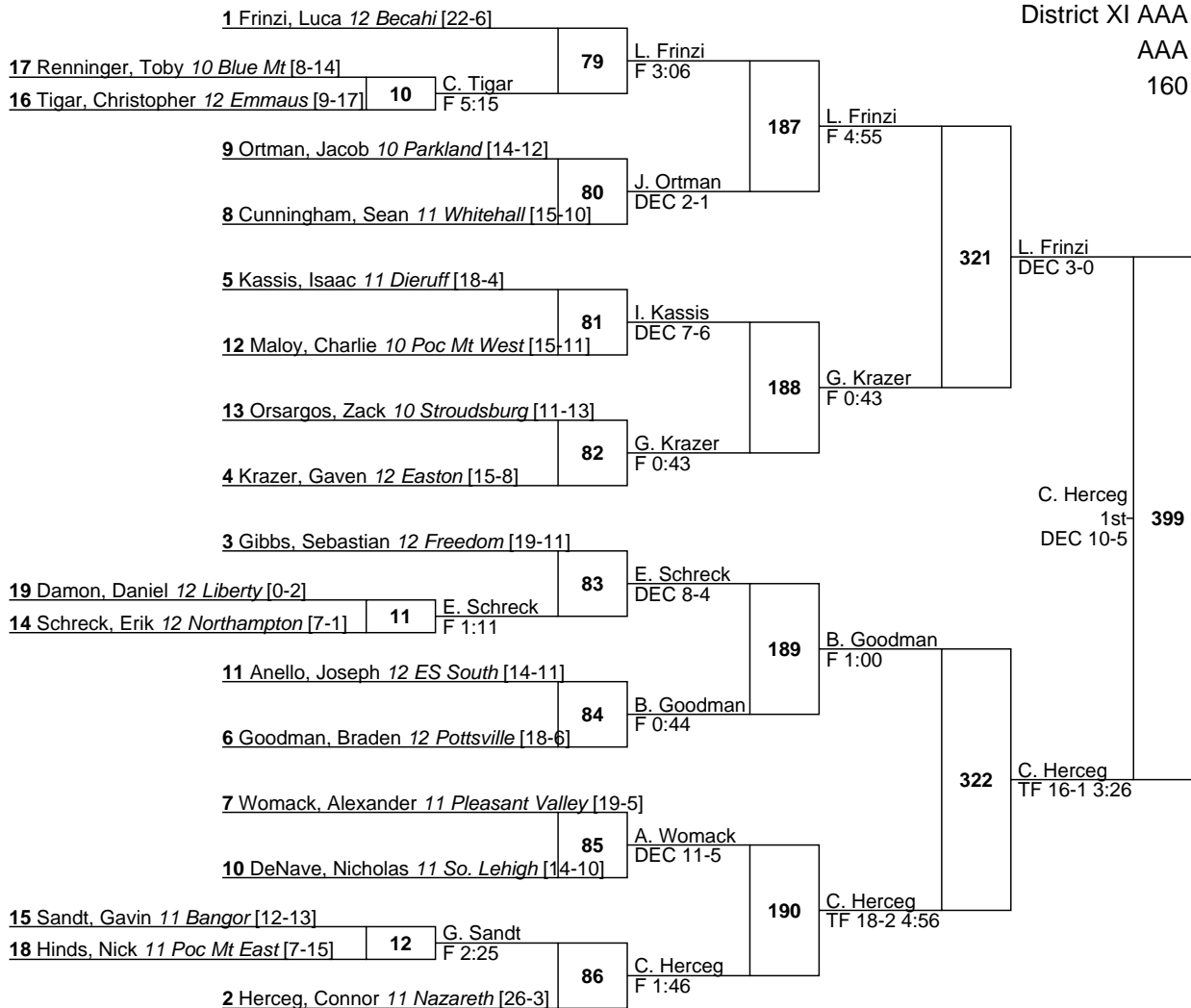

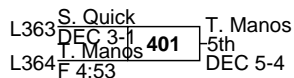
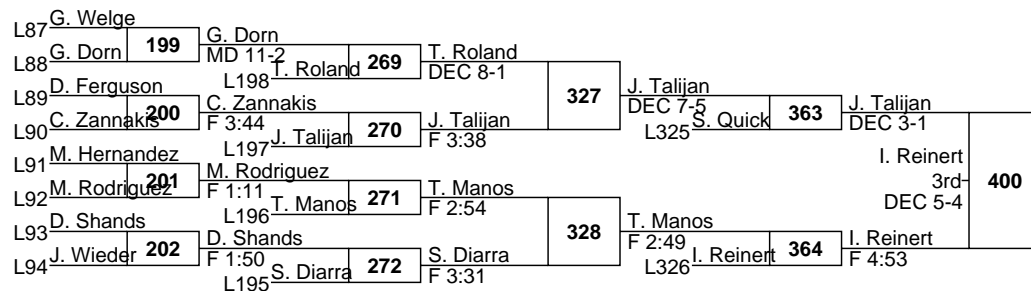
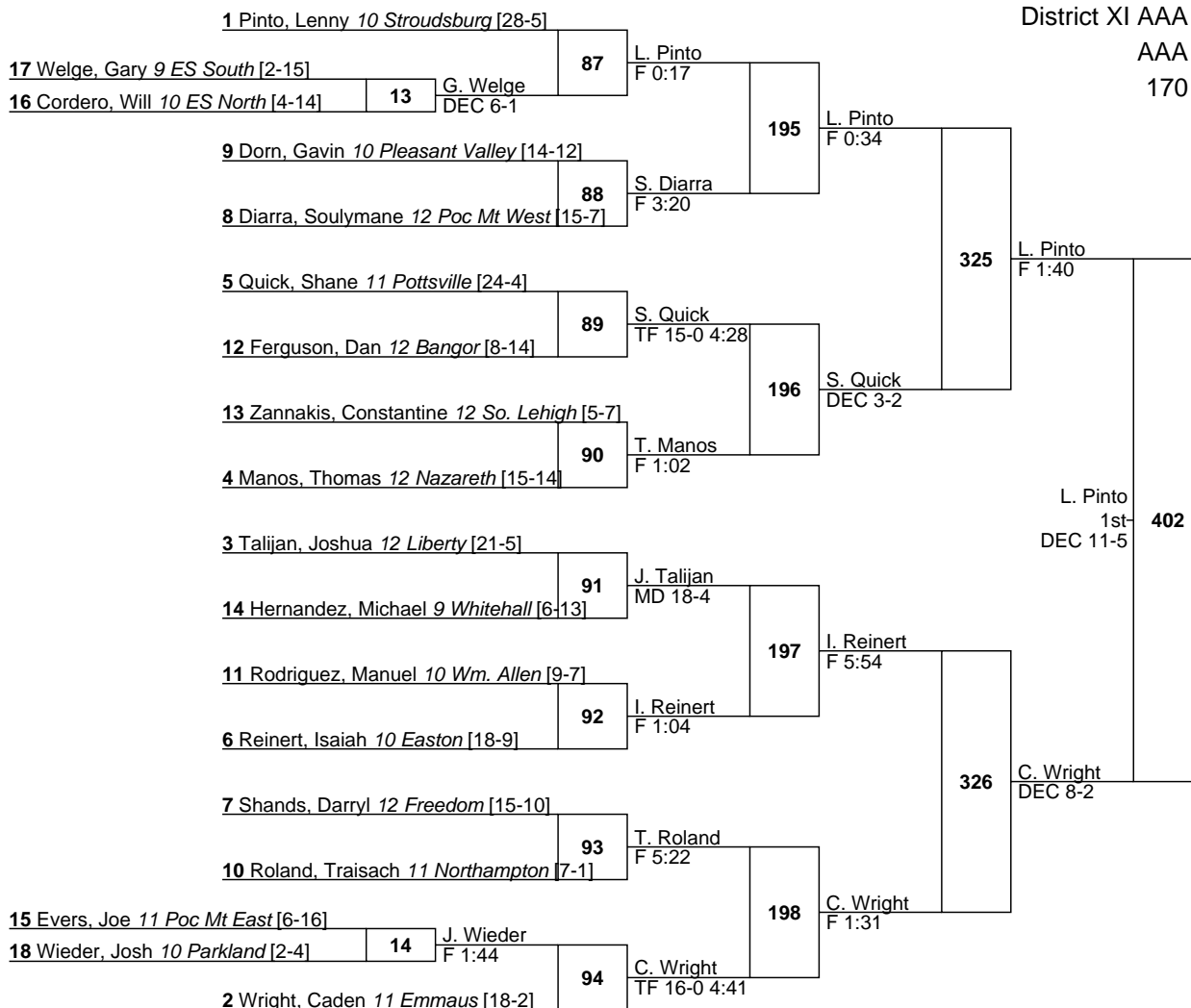

1 Schrader, Joey 12 Bangor [24-2]

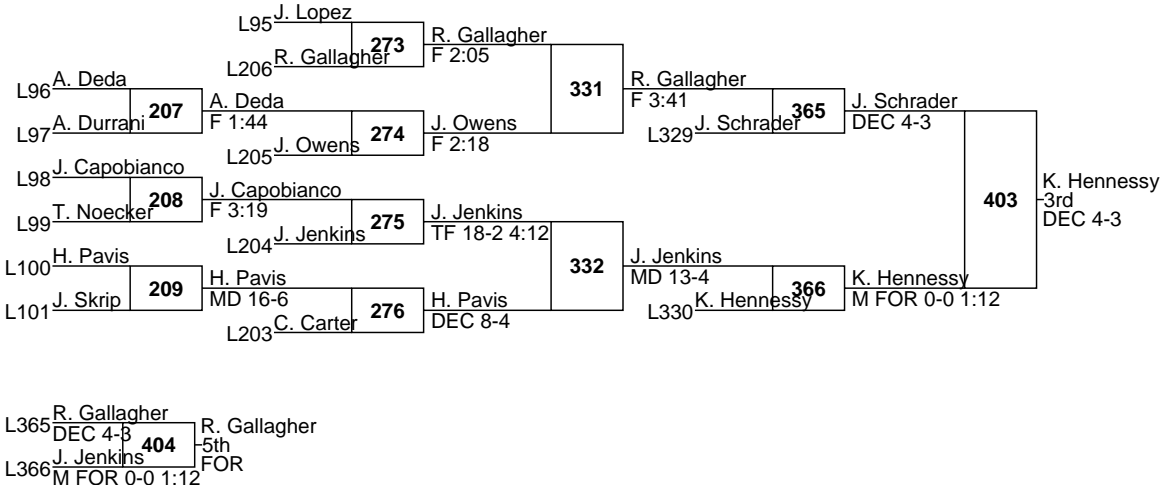
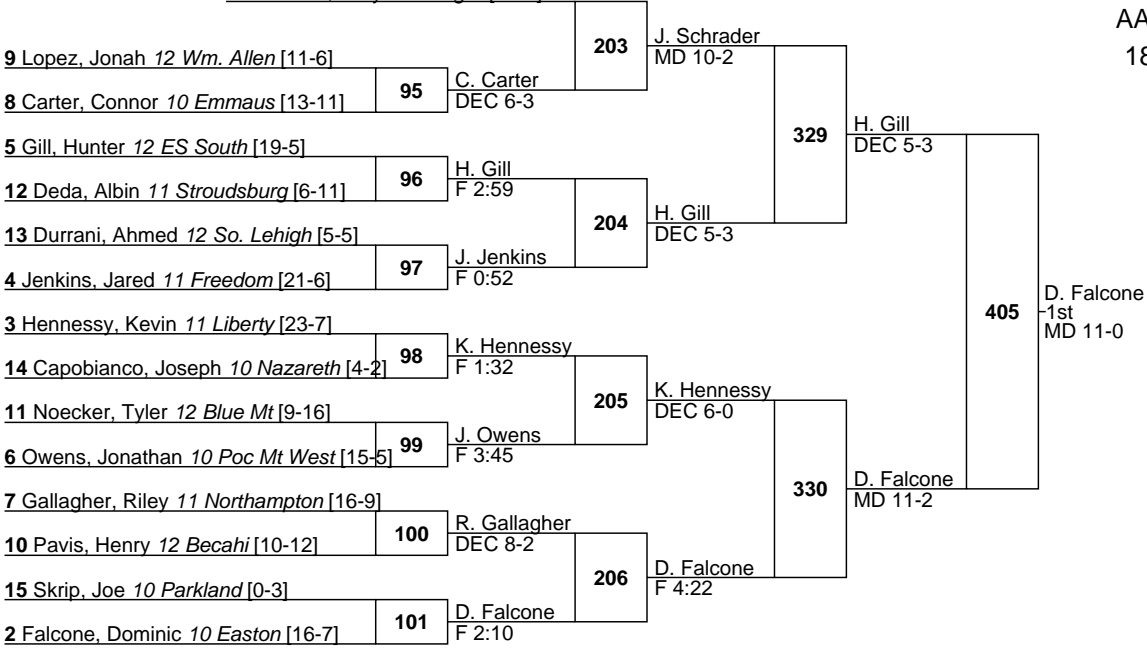

District XI AAA

AAA

285

